



SWEP EQUIPMENT CATALOGUE

FEBRUARY 2019

VERSION: 1 | UPDATED: FEBRUARY 2019



Quality Equipment
Enterprise Solutions
Home & Community





Aidacare & SWEP

Aidacare are proud to be recognised as a SWEP contracted service provider for a large range of products included in the recently announced low cost/high volume/non-customised equipment contract. Our commitment to all SWEP stakeholders including prescribing healthcare professionals and most importantly, the SWEP client, is to provide the very best service and product quality available.

For the healthcare prescriber, Aidacare offer industry leading support to assist in the provision of equipment for your clients.

- All contracted products are available for trial, anywhere in Victoria, to enable assessment of suitability for your clients specific needs. Our equipment consultants can meet with you at any location, including client's private homes, to demonstrate and trial items.
- Dedicated SWEP display stock located in each of the Aidacare showrooms is available to enable prescribers to meet with clients on-site to trial and assess all required items in a professional environment.
- Many Aidacare showrooms even offer prescribers use of a private office and meeting room to utilise while meeting with clients or just to catch up on admin and reports.
- Specialist complex rehab & seating staff to assist and support with prescription of customised and specialised equipment.
- Clinical education and support via the Aidacare Professional Training program and workshops.
- Service and repair of all contracted items with our workshop and mobile technicians.

General customer service and support including the booking of trials and any general advice and information required.

Our electronic catalogue is available for download at www.aidacare.com.au/globalassets/resources/swep_catalogue.pdf

For information on any of the extensive range of products available from Aidacare please browse the complete online Aidacare catalogue at www.aidacare.com.au

For additional information, please contact your local Aidacare office directly on **1300 133 120** or email swep@aidacare.com.au

The State-wide Equipment Program (SWEP) is a sub-division of Ballarat Health Services which oversees a number of different 'assistive technology' programs.

SWEP provides Victorian people who either have a permanent or long-term disability or are frail aged with subsidised aids, equipment and home and vehicle modifications to enhance their independence and facilitate community participation.

Programs within the Victorian aids & equipment state-wide equipment network are funded by the Department of Human Services and include the following programs:

- Aids & Equipment Program (A&EP)
- Continence Aids (CA)
- Domiciliary Oxygen Program (DOP)
- National Disability Insurance Scheme (NDIS)
- Supported Accommodation Equipment Assistance Scheme (SAEAS)
- Top-up fund for Children (TFC)
- Vehicle Modification Subsidy Scheme (VMSS)

The low cost/high volume/non-customised equipment contract has been established to support the Aids & Equipment Program.

The Aids & Equipment Program (A&EP) provides subsidised aids, equipment and home modifications to enhance independence in the home, facilitate community participation and support families and carers in their role.

To be eligible, you must be a Victorian Resident, living independently in the community with a permanent/long term disability and/or frail aged.

Please refer to the A&EP guidelines located the following website for further eligibility requirements:

<http://swep.bhs.org.au/aids-and-equipment>

State Wide Distribution Network

AIDACARE & NETWORK PARTNER LOCATIONS

MELBOURNE DC/OFFICE

35 - 37 Tinning St,
Brunswick VIC 3056
Tel: (03) 9981 2100
Fax: (03) 9384 2088

MELBOURNE NORTH

82 Albion St,
Brunswick East VIC 3057
Tel: (03) 9981 2100
Fax: (03) 9384 2088

MELBOURNE SOUTH

313 Warrigal Rd,
Cheltenham VIC 3192
Tel: (03) 9584 1644
Fax: (03) 9584 0562

BENDIGO

51 Bridge St,
Bendigo VIC 3550
Tel: (03) 5441 8213
Fax: (03) 5441 7762

MILDURA

18 Eighth St,
Mildura VIC 3500
Tel: (03) 5022 0755
Fax: (03) 5021 1845

GEELONG

38 - 42 Mercer St,
Geelong VIC 3220
Tel: (03) 5223 2263
Fax: (03) 5223 2269

ALBURY

347 Urana Rd,
Lavington NSW 2641
Tel: (02) 6040 3444
Fax: (02) 6040 3222

ACTION AIDS

2/4 Dooen Rd,
Horsham VIC 3400
Tel: 1800 819 992

ACCESS REHAB

97 - 99 Princes Street,
Traralgon VIC 3844
70 - 72 Princes Hwy,
Sale VIC 3850
Tel: 1300 723 830



CALL 1300 133 120

Call this number to be automatically diverted to your local Aidacare office (for the price of a local call).



Product Index

Bathroom & Toilet



Shower Commodes	04
Shower Commode Accessories	08
Shower Seating	09
Toileting Aids	10

Bedroom



Bedside Commodes	12
Air Mattress Overlays & Replacements	13

Chairs



Powerlift Recline Chairs	14
Day Chairs	16

Cushions & Seating



Pressure Care Cushions	17
Pressure Care Cushion Accessories	17

Manual Handling



Lifters	22
Slings	23

Mobility Scooters



Mobility Scooters	24
-------------------	----

Mobility Walking Frames & Aids



Seat Walkers / Rollators	25
Walking Frames & Aids	27

Mobility Wheelchairs



Folding Wheelchairs	28
Tilt & Recline Wheelchairs	30
Paediatric Wheelchairs	31
Wheelchair Accessories	33



Shower Commodes



Aspire 460mm Swing Away Footrest Commode

- 8° backrest angle ensures patient comfort
- Improved over toilet clearance
- Integrated access trough improves hygiene whilst maintaining toilet bowl clearance height of 465mm
- 4x total locking stainless steel castors provide brake access from all angles
- Safety arms prevent falls and swing back out of the way for transfers
- Open armrests style accommodates a wider sitting surface whilst maintaining a smaller base footprint for improved accessibility
- Angle adjustable backrest from 8° to 18° for improved seating comfort
- Ultra low seat height of 590mm which can be reduced to 490mm when customised
- Pan carrier and open seat included



Self propelled model available



*SWEP consumer co-contribution may be required dependent on accessories/modifications requested

Code	Description	Overall Height	Overall Width	Seat Width	Backrest Height	Armrest Height	Anterior Seat Height	Posterior Seat Height	S.W.L
BTC065900SP2*	Swing Away Footrest - 460mm - Att Propelled - S/Steel (LOW) *Not available for HIRE	Custom to size	535mm	460mm	305mm	225mm	590mm	560mm	200kg
BTC065900SP1	Swing Away Footrest - 460mm - Att Propelled - S/Steel	895 - 995mm	535mm	460mm	305mm	225mm	590mm	560mm	200kg
BTC066100SP3	Swing Away Footrest - 460mm - Self Propelled - S/Steel	895 - 995mm	665mm	460mm	305mm	225mm	590mm	560mm	200kg



Aspire 460mm Weight Bearing Commode

- 8° backrest angle ensures patient comfort
- Improved over toilet clearance
- Integrated access trough improves hygiene whilst maintaining toilet bowl clearance height of 465mm
- 4x total locking stainless steel castors provide brake access from all angles
- Safety arms prevent falls and swing back out of the way for transfers
- Open armrests style accommodates a wider sitting surface whilst maintaining a smaller base footprint for improved accessibility
- Easy-slide weight bearing platform footrest slides completely away for transfers
- Pan carrier and open seat included



Self propelled model available



*SWEP consumer co-contribution may be required dependent on accessories/modifications requested

Code	Description	Overall Height	Overall Width	Seat Width	Backrest Height	Armrest Height	Anterior Seat Height	Posterior Seat Height	S.W.L
BTC066000SP1	WB Platform - 460mm - Att Propelled - S/Steel	995mm	535mm	460mm	305mm	225mm	590mm	560mm	200kg
BTC066200SP3	WB Platform - 460mm - Self Propelled - S/Steel	995mm	665mm	460mm	305mm	225mm	590mm	560mm	200kg



\$0*
CONSUMER
CO-CONTRIBUTION



Aspire 530mm Swing Away Footrest Commode

- 8° backrest angle ensures patient comfort
- Improved over toilet clearance
- Integrated access trough improves hygiene whilst maintaining toilet bowl clearance height of 465mm
- 4x total locking stainless steel castors provide brake access from all angles
- Safety arms prevent falls and swing back out of the way for transfers
- Open armrests style accommodates a wider sitting surface whilst maintaining a smaller base footprint for improved accessibility
- Angle adjustable backrest from 8° to 18° for improved seating comfort
- Ultra low seat height of 590mm which can be reduced to 490mm when customised
- Pan carrier and open seat included



Self propelled model available



*SWEP consumer co-contribution may be required dependent on accessories/modifications requested

Code	Description	Overall Height	Overall Width	Seat Width	Backrest Height	Armrest Height	Anterior Seat Height	Posterior Seat Height	S.W.L
BTC066060SP1	Swing Away - 530mm - Att Propelled - S/Steel	995mm	605mm	530mm	305mm	225mm	590mm	560mm	200kg
BTC066065SP3	Swing Away - 530mm - Self Propelled - S/Steel	995mm	735mm	530mm	305mm	225mm	590mm	560mm	200kg

\$0*
CONSUMER
CO-CONTRIBUTION



Aspire 530mm Weight Bearing Commode

- 8° backrest angle ensures patient comfort
- Integrated access trough improves hygiene whilst maintaining toilet bowl clearance height of 465mm
- Safety arms prevent falls and swing back out of the way for transfers
- Easy-slide weight bearing platform footrest slides completely away for transfers
- 4x total locking stainless steel castors provide brake access from all angles
- Open armrests style accommodates a wider sitting surface whilst maintaining a smaller base footprint for improved accessibility
- Improved over toilet clearance
- Pan carrier and open seat included



Self propelled model available



*SWEP consumer co-contribution may be required dependent on accessories/modifications requested

Code	Description	Overall Height	Overall Width	Seat Width	Backrest Height	Armrest Height	Anterior Seat Height	Posterior Seat Height	S.W.L
BTC066050SP1	WB Platform - 530mm - Att Propelled - S/Steel	995mm	605mm	530mm	305mm	225mm	590mm	560mm	200kg
BTC066055SP3	WB Platform - 530mm - Self Propelled - S/Steel	995mm	735mm	530mm	305mm	225mm	590mm	560mm	200kg

\$0*
CONSUMER
CO-CONTRIBUTION



Aspire 600mm Swing Away Footrest Commode

- 8° backrest angle ensures patient comfort
- Safety arms prevent falls and swing back out of the way for transfers
- Open armrests style accommodates a wider sitting surface whilst maintaining a smaller base footprint for improved accessibility
- 4x total locking stainless steel castors provide brake access from all angles
- Self Propelled Model Available
- Ultra low seat height of 590mm which can be reduced to 490mm when customised
- Angle adjustable backrest from 8° to 18° for improved seating comfort
- Integrated access trough improves hygiene whilst maintaining toilet bowl clearance height of 465mm
- Pan carrier and open seat included



*SWEP consumer co-contribution may be required dependent on accessories/modifications requested

Code	Description	Overall Height	Overall Width	Seat Width	Backrest Height	Armrest Height	Anterior Seat Height	Posterior Seat Height	S.W.L
BTC061300SP1	Swing Away - 600mm - Att Propelled - S/Steel	995mm	675mm	600mm	305mm	225mm	590mm	560mm	200kg



Aspire 600mm Weight Bearing Commode - 400kg



- Heavy duty reinforced wide frame can support bariatric users up to 400kg
- 4x total locking stainless steel castors provide brake access from all angles
- Height adjustable reinforced armrests offer drop flat positioning to assist with lateral slide transfers
- Easy-slide weight bearing platform footrest slides completely away for transfers
- Pan carrier and open seat included



*SWEP consumer co-contribution may be required dependent on accessories/modifications requested

Code	Description	Overall Height	Overall Width	Seat Width	Backrest Height	Armrest Height	Anterior Seat Height	Posterior Seat Height	S.W.L
BTC061400SP1	WB Platform - 600mm - Att Propelled - S/Steel - 400kg	995mm	725mm	600mm	300mm	290mm	590mm	560mm	400kg

Aspire Tilt & Recline Shower Commode



30° of backrest angle adjustment in 10° increments for effortless repositioning and maximum user comfort

Backrest may be configured as full length or 3/4 length with the top 1/4 section removable. Open back straps provide greater access for bathing needs

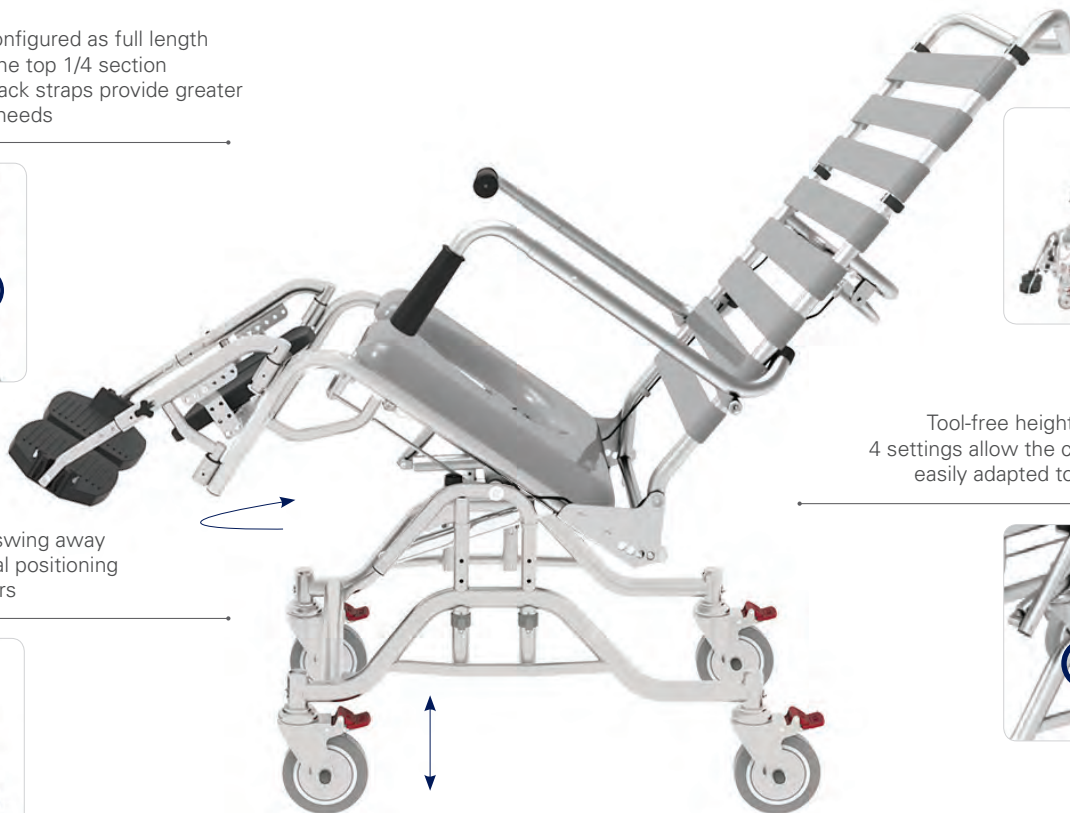
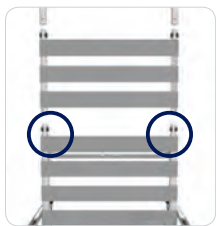

Tool-free height adjustment to 4 settings allow the commode to be easily adapted to varying needs

Height adjustable, swing away footrests for optimal positioning and ease of transfers

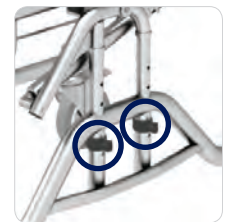

- 35° of gas-assisted tilt & recline functionality minimises manual handling efforts during the showering process
- 4 lockable stainless steel castors maximise safety by providing carer access to a brake at all angles around the commode
- Safety arms prevent falls and swing back out of the way for transfers



Code	Description	Overall Height	Overall Width	Seat Width	Backrest Height	Armrest Height	Anterior Seat Height	Posterior Seat Height	S.W.L
BTC066030SP1	460mm - Attendant Propelled	1315 - 1485mm	560mm	460mm	900mm	275mm	460 - 630mm	460 - 620mm	250kg
BTC066040SP1	530mm - Attendant Propelled	1315 - 1485mm	630mm	530mm	900mm	275mm	460 - 630mm	460 - 620mm	250kg



Ki Mobility Raz Shower Commode - Attendant Propelled



- Offers Ischial & Pelvic Alignment System (IPAS) for clients with a posterior or anterior rotated pelvis
- 4" height adjustment
- Adjustable tension fabric backrest
- Dual locking castors



Code	Description	Seat Width	Seat Depth	Seat Height	Armrest Height	S.W.L
BTC091400	Ki Mobility Raz Shower Commode - Att Propelled	460mm	400 - 480mm	510 - 610mm	170 - 240mm	159kg



Ki Mobility Raz Shower Commode - Self Propelled



- Offers Ischial & Pelvic Alignment System (IPAS) for clients with a posterior or anterior rotated pelvis
- 4" height adjustment
- Adjustable tension fabric backrest
- Dual locking castors



Code	Description	Seat Width	Seat Depth	Seat Height	Armrest Height	S.W.L
BTC091410	Ki Mobility Raz Shower Commode - Self Propelled	460mm	405 - 480mm	510 - 610mm	190 - 270mm	159kg



Ki Mobility Raz Shower Commode - Attendant Tilt & Ki Mobility Raz Shower Commode - Attendant Tilt - Compact



- Offers Ischial & Pelvic Alignment System (IPAS) for clients with a posterior or anterior rotated pelvis
- Tilts up to 40° for extra pressure reduction and comfort
- 4" height adjustment
- Adjustable tension fabric backrest
- Molded headrest and fixture



Code	Description	Seat Width	Seat Depth	Seat Height	Armrest Height	S.W.L
BTC091420	Ki Mobility Raz Shower Commode - Att Prop - Tilt	460mm	405 - 480mm	540 - 640mm	180 - 250mm	159kg
BTC091425	Ki Mobility Raz Shower Commode - Att Prop - Tilt - Compact	460mm	405 - 480mm	540 - 640mm	180 - 250mm	159kg



Aspire Shower Commode Accessories

NOTE : These items are not awarded on the SWEP contract.
These items are available for purchase on approval from SWEP.



Code	Description
1	BTC066500 Shower Commode Seat - Aspire - Closed 410mm
	BTC066700 Shower Commode Seat - Aspire - Closed 460mm
	BTC066600 Shower Commode Seat - Aspire - Open 460mm
2	BTC066750 Shower Commode Seat - Aspire - Open 530mm
	BTC066800 Shower Commode Seat - Aspire - Open 600mm
3	BTC089124 Shower Commode Seat - Aspire - Hand Made Pressure Reducing - 320mm - Closed Front
	BTC089128 Shower Commode Seat - Aspire - Hand Made Pressure Reducing - 400mm - Closed Front
	BTC089140 Shower Commode Seat - Aspire - Hand Made Pressure Reducing - 460mm - Closed Front
	BTC089180 Shower Commode Seat - Aspire - Hand Made Pressure Reducing - 500mm - Closed Front
	BTC089240 Shower Commode Seat - Aspire - Hand Made Pressure Reducing - 650mm - Closed Front
	BTC089220 Shower Commode Seat - Aspire - Hand Made Pressure Reducing - 600mm - Closed Front
4	BTC089122 Shower Commode Seat - Aspire - Hand Made Pressure Reducing - 320mm - Open Front
	BTC089126 Shower Commode Seat - Aspire - Hand Made Pressure Reducing - 400mm - Open Front
	BTC089130 Shower Commode Seat - Aspire - Hand Made Pressure Reducing - 460mm - Open Front
	BTC089170 Shower Commode Seat - Aspire - Hand Made Pressure Reducing - 500mm - Open Front
	BTC089190 Shower Commode Seat - Aspire - Hand Made Pressure Reducing - 550mm - Open Front
	BTC089210 Shower Commode Seat - Aspire - Hand Made Pressure Reducing - 600mm - Open Front
	BTC089230 Shower Commode Seat - Aspire - Hand Made Pressure Reducing - 650mm - Open Front
	BTC089150 Shower Commode Seat - Aspire - Hand Made Pressure Reducing - 460mm - Open Left
	BTC089160 Shower Commode Seat - Aspire - Hand Made Pressure Reducing - 460mm - Open Right
5	BTC067050 Advanced Headrest - Aspire Shower Commodes
6	BTC067100 Pelvic Strap - Adjustable - Aspire Shower Commodes
7	BTC067103 IV Pole - Adjustable - Aspire Shower Commodes
8	BTC067105 Stump Support (left/right) - Clamp On - Aspire Shower Commodes
9	BTC067110 Shower Commode Elevating Legrest - Aspire - Left
	BTC067115 Shower Commode Elevating Legrest - Aspire - Right



Shower Seating

\$0
CONSUMER
CO-CONTRIBUTION



Aspire Shower Chair

- Safe Working Load (SWL) of 200kg. Tested to AS/NZS39737:2009
- Contoured plastic seat with drainage holes and windows - Provides postural support, improves drainage and reduces skin adhesion
- Height adjustable legs - Easy push button height adjustment for changing needs
- Additional height increments on one leg - Accommodates uneven surfaces
- Raised armrests - Assist the user transferring on and off the chair
- All frames are individually treated for corrosion resistance
- Durable non-slip feet - Provide excellent grip and stability in wet conditions and a stainless steel washer within enhances durability



Code	Description	Overall Height	Overall Width	Overall Depth	Seat Depth	Seat Width	Between Arms	Seat Height	S.W.L
BTS118000	Shower Chair with Arms - Steel	735 - 910 mm	512 mm	570 mm	400 mm	440 mm	470 mm	375 - 550 mm	200kg
BTS118005*	Shower Chair with Arms - Aluminium *Not available for HIRE	735 - 910 mm	512 mm	570 mm	400 mm	440 mm	470 mm	375 - 550 mm	200kg

\$0
CONSUMER
CO-CONTRIBUTION



Aspire Shower Stool

- Safe Working Load (SWL) of 175kg. Tested to AS/NZS39737:2009
- Clip on seat attachment - For easy assembly and cleaning
- Height adjustable legs - Easy push button height adjustment for changing needs
- Additional height increments on one leg - Accommodates uneven surfaces
- All frames are individually treated for corrosion resistance
- Raised armrests - Assist the user transferring on and off the chair
- Seat with anterior tilt - Facilitates standing from sitting and provides greater comfort for stiff or painful hips
- Raised armrests - Assist the user transferring on and off the stool
- Durable non-slip feet - Provide excellent grip and stability in wet conditions and a stainless steel washer within enhances durability



Padded seat & backrest option available



Code	Description	Overall Height	Overall Width	Overall Depth	Seat Depth	Seat Width	Between Arms	Seat Height	S.W.L
BTS119000	Shower Stool - Steel	670 - 855 mm	545 mm	400 mm	310 mm	375 mm	495 mm	470 - 655 mm	175kg
BTS119005*	Shower Stool - Aluminium *Not available for HIRE	670 - 855 mm	545 mm	400 mm	310 mm	375 mm	495 mm	470 - 655 mm	175kg
BTS119025	Shower Stool with Padded Seat & Back - Aluminium	670 - 855 mm	545 mm	400 mm	310 mm	375 mm	495 mm	470 - 655 mm	175kg

Toileting Aids



\$0
CONSUMER
CO-CONTRIBUTION



Aspire Over Toilet Aid



- Safe Working Load (S.W.L) of 175kg. Tested to AS/NZS3973.7:2009
- Raised armrests – Assist the user transferring on and off the Over Toilet Aid
- Additional height increments on one leg – Accommodates uneven surfaces
- Height adjustable legs – Easy push button height adjustment for changing needs
- Comfortable, contoured seat with clip on attachment – For easy assembly and cleaning. Padded seat available, sold separately (BTT145110)
- All frames are individually treated for corrosion resistance
- Removable, moulded splash guard provided – Easily removed for transport and cleaning
- Durable non-slip feet – Provide excellent grip and stability in wet conditions. Stainless steel washer within enhances durability
- Available in Aluminium or Treated Steel



Code	Description	Overall Height	Overall Width	Overall Depth	Seat Depth	Seat Width	Seat Height	Between Arms	S.W.L
BTT145000	Over Toilet Aid - Steel	700 - 880 mm	512 mm	625 mm	435 mm	370 mm	450 - 630 mm	460 mm	175kg
BTT145005*	Over Toilet Aid - Aluminium *Not available for HIRE	700 - 880 mm	512 mm	625 mm	435 mm	370 mm	450 - 630 mm	460 mm	175kg

\$0
CONSUMER
CO-CONTRIBUTION



Aspire Over Toilet Aid - Wide



- Safe Working Load (S.W.L) of 175kg. Tested to AS/NZS3973.7:2009
- Raised armrests – Assist the user transferring on and off the Over Toilet Aid
- Additional height increments on one leg – Accommodates uneven surfaces
- Height adjustable legs – Easy push button height adjustment for changing needs
- Comfortable, contoured seat with clip on attachment – For easy assembly and cleaning. Padded seat available, sold separately (BTT145110)
- All frames are individually treated for corrosion resistance
- Removable, moulded splash guard provided – Easily removed for transport and cleaning.
- Durable non-slip feet – Provide excellent grip and stability in wet conditions. Stainless steel washer within enhances durability
- Available in Aluminium or Treated Steel



Code	Description	Overall Height	Overall Width	Overall Depth	Seat Depth	Seat Width	Seat Height	Between Arms	S.W.L
BTT145010	Over Toilet Aid - Wide - Steel	700 - 880 mm	570 mm	625 mm	435 mm	370 mm	450 - 630 mm	525 mm	175kg
BTT145015*	Over Toilet Aid - Wide - Aluminium *Not available for HIRE	700 - 880 mm	570 mm	625 mm	435 mm	370 mm	450 - 630 mm	525 mm	175kg



\$0
CONSUMER
CO-CONTRIBUTION



Aspire Over Toilet Aid - MAXI

- Super heavy duty adjustable width over toilet aid
- Soft padded flip up seat for easy cleaning
- Reinforced aluminium frame accommodates bariatric users and is corrosion resistant
- Height adjustable legs with easy circlip adjustment points
- Raised armrests to assist the user in transferring on and off the stool
- Durable non-slip feet provide excellent grip and stability in wet conditions. Stainless steel washer enhances durability
- To create a MAXI bedside commode (BEC045120), simply add a padded backrest (as shown in MAXI Shower Chair above)



Highly Adjustable



Code	Description	Overall Height	Overall Width	Overall Depth	Seat Depth	Seat Width	Seat Height	Between Arms	S.W.L
BTT145020	MAXI Over Toilet Aid	670 - 790 mm	645 - 845 mm	495 mm	455 mm	575 - 775 mm	455 - 575 mm	575 - 775 mm	310kg

\$0
CONSUMER
CO-CONTRIBUTION



Aspire Toilet Seat Raiser - No Lid

- Assists toileting and transfers by raising the toilet seat height
- Moulded plastic seat sits securely over the existing toilet
- Fits all standard toilet seats
- Adjustable mounting brackets to allow for correct fitting to different size toilets
- Available in two different height versions to suit individual requirements



Code	Description	Overall Height	Unit Weight	S.W.L
BTT149800	Toilet Seat Raiser - 50mm - No Lid	50 mm	1.4 kg	200kg
BTT150300	Toilet Seat Raiser - 150mm - No Lid	150 mm	1.4 kg	200kg



Bedside Commodes



\$0
CONSUMER
CO-CONTRIBUTION



Aspire Classic Bedside Commode



- Allows for toileting in the bed room for users unable to travel between the bedroom and bathroom
- Raised Padded Armrests
- Easy Clean Vinyl Surfaces
- Height Adjustable
- Removable, Padded Seat
- Non-Slip Rubber Tips



Code	Description	Overall Height	Overall Width	Overall Depth	Seat Depth	Seat Width	Backrest Height	Seat Height	Product Weight	S.W.L
BEC045005	Classic Bedside Commode - Champagne Vinyl	900 - 1040 mm	560 mm	600 mm	440 mm	450 mm	450 mm	475 - 615 mm	5.5 kg	125 kg



Air Mattress Overlays & Replacements

\$0*
CONSUMER
CO-CONTRIBUTION



M Suitable for **medium** risk patients

Aspire Lifecomfort Active Air 4 Mattress Overlay



The Active Air 4 is a lightweight, easy to use Overlay that is placed on top of an existing foam mattress. Featuring COMFORT CONTROL and offering a suite of other features, the Active Air 4 caters to users considered to be "At Risk" of Pressure Injury. An ideal solution for Home Care or Facility environments.

- Breathable multi-stretch cover
- Integrated cable management
- Simple and easy to operate semi-digital pump
- Patented cable lock protection
- Welded seams and zip protection
- 4" Overlay + Memory Foam



*SWEP consumer co-contribution may be required dependent on clients available pressure care subsidy balance

Code	Description	Height	Width	Length	No. Of Cells	Static Head Cells	Cell Cycle	Cycle Time	S.W.L	Warranty
PTM639100	Active Air 4" Mattress Overlay	100 mm	850 mm	2000 mm	19	3	1 in 2	10 / 15 / 20 mins	135 kg	2yr/1yr

\$0*
CONSUMER
CO-CONTRIBUTION



H Suitable for **high** risk patients

Aspire Lifecomfort Active Air 8 Mattress Replacement



The Active Air 8 is a dynamic mattress replacement suitable for users at "High Risk" of Pressure Injury. Featuring AUTODETECT, and AUTOPROTECT, together with CELL-IN-CELL technology, the Active Air 8 provides the highest levels of care into Acute and Long Term care environments. The Active Air 8's innovative features ensure lowest interface pressures with an easy-to-use digital pump.

- Breathable multi-stretch cover
- Integrated cable management
- Simple and easy to operate digital pump
- Patented cable lock protection
- Welded seams and zip protection
- 8" Mattress replacement



*SWEP consumer co-contribution may be required dependent on clients available pressure care subsidy balance

Code	Description	Height	Width	Length	No. Of Cells	Static Head Cells	Cell Cycle	Cycle Time	S.W.L	Warranty
PTM639300	Active Air 8" Mattress Replacement - Single	200 mm	900 mm	2000 mm	20	3	1 in 2	10/15/20/25/30 mins	200 kg	2yr/1yr
PTM639310*	Active Air 8" Mattress Replacement - King Single *Not available for HIRE	200 mm	1050 mm	2000 mm	20	3	1 in 2	10/15/20/25/30 mins	200 kg	2yr/1yr

Powerlift Recline Chairs



Aspire Montana Electric Lift Recline Chair



- Heavy duty and supportive lounge chair with electric lift and recline functionality
- Designed for maximum comfort and support through the lower back, the smooth mechanism is infinitely adjustable through range to offer the best possible support
- Dual-drive high strength lift mechanism offers a 220kg maximum user weight to match the generous seat proportions
- Constructed with durable foams and comfortable micro-suede fabric, the Aspire Montana Electric Lift Recline Chair creates a contemporary look and feel to compliment existing décor



Code	Description	Seat Height	Seat Depth	Seat Width	Overall Length	Overall Width	Backrest Height	S.W.L
CHP227400	Montana Electric Recline Chair	510 mm	530 mm	630 mm	880 mm	940 mm	600 mm	220 kg



Pride C1 Powerlift Recliner



- Rise & Recline (single motor - foot raise only with recline function)
- Petite to small lift chair with fully removable upholstery components
- Engineered furniture hardwood frame
- Emergency battery backup system in case of power failure

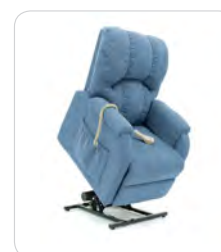

Arctic Blue



*SWEP consumer co-contribution may be required dependent on accessories/modifications requested

Code	Description	Seat Height	Seat Depth	Seat Width	Back Width	Backrest Height	User Height	Battery Backup	S.W.L
CHP197209	C1 Recliner - Arctic Blue	410 - 460 mm	510 mm	460 mm	510 mm	660 mm	163 cm & below 5'4"	Yes	113 kg
CHP197211	C1 Recliner - Chocolate	410 - 460 mm	510 mm	460 mm	510 mm	660 mm	163 cm & below 5'4"	Yes	113 kg



\$0*
CONSUMER
CO-CONTRIBUTION



Pride C5 Powerlift Recliner

- Rise & Recline (single motor - foot raise only with recline function)
- Medium to large chaise lounge with fully removable upholstery components to suit the user.
- Engineered furniture steel frame
- Emergency battery backup system in case of power failure

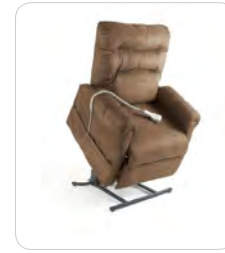

Chocolate

Pride



*SWEP consumer co-contribution may be required dependent on accessories/modifications requested

Code	Description	Seat Height	Seat Depth	Seat Width	Back Width	Backrest Height	User Height	Battery Backup	S.W.L
CHP197104	C5 Recliner - Arctic Blue	460 mm	460 - 510 mm	560 mm	710 mm	660 - 710 mm	163 cm - 183 cm 5'4" - 6'	Yes	170 kg
CHP197102	C5 Recliner - Chocolate	460 mm	460 - 510 mm	560 mm	710 mm	660 - 710 mm	163 cm - 183 cm 5'4" - 6'	Yes	170 kg



Pride LC - 358XL Powerlift Recliner

- Engineered furniture laminate/hardwood frame
- Patented, quiet & smooth lift system
- Large side pocket
- Hand control can be easily moved to left-hand side
- Integrated emergency battery backup (batteries not included)
- External transformer for easy access to battery backup

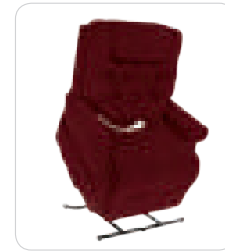

Burgundy

Pride



Code	Description	Seat Height	Seat Depth	Seat Width	Back Width	Backrest Height	User Height	Battery Backup	S.W.L
CHP197219	LC 358XL Recliner - Burgundy	510 mm	560 mm	660 mm	600 mm	740 mm	170 cm - 186 cm 5'6" - 6'1"	Yes	227 kg
CHP197220	LC 358XL Recliner - Latte	510 mm	560 mm	660 mm	600 mm	740 mm	170 cm - 186 cm 5'6" - 6'1"	Yes	227 kg



Day Chairs



\$0
CONSUMER
CO-CONTRIBUTION



Aspire Low Back Classic Day Chair

- A versatile, low back orthopaedic chair
- Contoured Backrest – Provides postural support
- Softly padded armrests, seat and back upholstery are comfortable and supportive
- Non-Slip Rubber Tips – Provide stability whilst sitting or transferring
- Easy clean vinyl surfaces
- Height Adjustable – Easy push button adjustment for comfortable positioning and changing needs
- Lightweight Design - lightweight yet sturdy design for easy manoeuvrability
- Powder Coated Steel Frame – Easy to clean, strong and durable
- Available in either Slate or Champagne Vinyl



Champagne Vinyl



Code	Description	Overall Height	Overall Width	Overall Depth	Seat Depth	Seat Width	Seat Height	Backrest Height	S.W.L
CHP208000	Low Back Classic Day Chair - Champagne Vinyl	845 - 1015 mm	580 mm	600 mm	440 mm	460 mm	430 - 605 mm	440 mm	160 kg
CHP208005	Low Back Classic Day Chair - Slate Vinyl	845 - 1015 mm	580 mm	600 mm	440 mm	460 mm	430 - 605 mm	440 mm	160 kg

\$0
CONSUMER
CO-CONTRIBUTION



Aspire Kitchen/Perching Stool

- Ideal for Kitchen Use – Positioned with an anterior tilt to aid the sitting to standing process
- Height Adjustable – Easy push button adjustment for comfortable positioning and changing needs
- Padded Seat and Backrest - Generous support surfaces for sitting comfort
- Non-Slip Tips - Provide stability whilst sitting or transferring
- Powder Coated Steel Frame – Easy to clean, strong and durable



Code	Description	Overall Height	Seat Height	Overall Width	Overall Depth	Seat Depth	Seat Width	Between Arms	S.W.L
CHP213500	Kitchen Stool	950 - 1100 mm	540 - 690 mm	545 mm	400 mm	310 mm	375 mm	495 mm	175 kg

Pressure Care Cushions



\$0*
CONSUMER CO-CONTRIBUTION

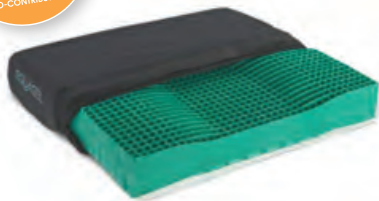

M Suitable for **medium** risk patients

EquaGel - Adjustable

- Gel cushion for anyone in need of a low-profile customisable comfortable cushion
- Comes with a fluid resistant, vapour permeable cover
- 12 degrees cooler than inflatable cushions which creates a more comfortable seating solution for patients
- Gel cushion absorbs vibrations
- 2" tall EquaGel in two stages

- Includes pelvic contour inserts to increase the amount of therapeutic gel supporting the pelvis

EQUAGEL



WIDTH (Size")	DEPTH (Size")	
	16"	18"
16"	PTC551011	PTC551013
18"	PTC551015	PTC551017
20"	PTC551019	PTC551021
22"	PTC551023	PTC551025

*SWEP consumer co-contribution may be required dependent on clients available pressure care subsidy balance

\$0*
CONSUMER CO-CONTRIBUTION



L Suitable for **low** risk patients

ROHO® - Mosaic

- Appropriate for everyday comfort and pressure injury prevention
- The Mosaic is excellent as a lounge-chair cushion and can also be used as a shower chair cushion
- Designed to provide a comfortable, functional and stable sitting environment for patients who are at risk of skin breakdown

- The Mosaic is also a Dry Floatation cushion but is made from softer plastic than the classic ROHO DF cushions. It is therefore lighter (0.5kg) but less rugged
- Interconnected air cells disperse pressure and promote stability as the pelvis sinks into them
- Maximum User Weight: 113 kg

ROHO



WIDTH (Size")	DEPTH (Size")	
	18"	16"
18"	PTC586300	PTC586200
16"	-	PTC586100

All models include

- 2 Way Stretch Cover
- Operating Instructions
- Hand Pump & Repair Kit
- 1 Year Warranty

*SWEP consumer co-contribution may be required dependent on clients available pressure care subsidy balance

Cushion Accessories

NOTE : These items are not awarded on the SWEP contract.

These items are available for purchase on approval from SWEP.

Code	Description	Code	Description
PTC595120	Cushion - ROHO Hybrid Elite Cover 16x16in	PTC595130	Cushion - ROHO Hybrid Elite Cover 18x20in
PTC595125	Cushion - ROHO Hybrid Elite Cover 18x18in	PTC595135	Cushion - ROHO Hybrid Elite Cover 22x20in

L Low Risk **M** Medium Risk **H** High Risk **V** Very High Risk



\$0*
CONSUMER
CO-CONTRIBUTION



M H Suitable for **medium - high** risk patients

ROHO® - Hybrid Elite

- Appropriate for clients with moderate to high risk of skin breakdown who require positioning support
- The Hybrid Elite combines the skin protection and shape matching ability of ROHO Dry Floatation with a contoured foam base
- The stability provided by the foam base assists "friction & shear" with safer transfers.
- The ROHO Dry Floatation system and 2-way stretch cover help reduce friction and shear whilst maximising blood flow
- Double valve design allows for improved pelvic alignment and stability while maintaining optimal immersion and dispersion of pressure away from the pelvic area
- All models include 2 way stretch cover, hand pump & repair kit, operating instructions and 2 years warranty
- Maximum User Weight: 225 kg



Hybrid Elite Cushion Assembly

Sizes listed are seat dimensions. The actual cushion is 1.5" longer to allow for the cushion to sit between the back canes.

WIDTH (Size")	DEPTH (Size")					
	20"	18"	17"	16"	15"	14"
24"	PTC594976	PTC594975	-	-	-	-
22"	PTC594974	PTC594973	-	-	-	-
20"	PTC594961	PTC594955	-	-	-	-
18"	PTC594972	PTC594954	PTC594959	PTC594958	-	-
17"	-	PTC594971	PTC594970	PTC594957	-	-
16"	PTC594963	PTC594953	PTC594969	PTC594952	PTC594968	-
15"	-	-	PTC594967	PTC594966	PTC594956	-
14"	-	-	-	PTC594965	PTC594964	PTC594962

*SWEP consumer co-contribution may be required dependent on clients available pressure care subsidy balance

\$0*
CONSUMER
CO-CONTRIBUTION



V Suitable for **high** risk patients

ROHO® Quadtro Select

- Appropriate for clients at very high risk of ischaemic ulcers and for management and recovery from existing pressure injury conditions
- ROHO Dry Floatation promotes circulation, and pressure relief whilst flexible neoprene cells reduce shear friction
- Quick-and-easy air compartment adjustment maximises function and utility
- Quadro Select cushions employ ISOFLO Memory Control which locks air into compartments to help maintain better postural integrity in addition to pressure reduction
- All models include 2 way stretch cover, hand pump & repair kit, operating instructions and 3 years warranty
- Maximum User Weight: Unlimited



ISOFLO - Open



ISOFLO - Closed

Note: This range can fit chairs from 13" x 13" to 22" x 22".

Sizes listed are seat dimensions.

V **High Profile (HP)**

- 4" (10cm) High Cells
- Higher Pressure Disbursement

H **Low Profile (LP)**

- 2" (5cm) High Cells
- Greater Stability



WIDTH (Cells / Size")	Profile	DEPTH (Size")						
		12 / 22"	11 / 20"	10 / 18.5"	9 / 16.75"	8 / 15"	7 / 13"	6 / 11"
13 / 24"	HP	PTC590110	PTC590100	PTC590000	-	-	-	-
12 / 22"	HP	PTC589900	PTC589800	PTC589600	PTC589550	-	-	-
	LP	-	-	PTC589700	-	-	-	-
11 / 20"	HP	PTC589200	PTC589000	PTC588800*	PTC589400*	PTC589300	-	-
	LP	PTC589210	PTC589100	PTC588900	PTC589500	-	-	-
10 / 18.5"	HP	PTC588200*	PTC588000*	PTC587700*	PTC588500*	PTC588300*	-	-
	MP	-	-	PTC593250	-	-	-	-
	LP	PTC588210	PTC588100	PTC587900	PTC588700	PTC588400	PTC588280	-
9 / 16.75"	HP	-	PTC592400*	PTC592200*	PTC593000*	PTC592800*	PTC592700*	-
	MP	-	-	PTC593220	-	-	-	-
	LP	-	PTC592500	PTC592300	PTC593200	PTC592900	PTC592710	-
8 / 15"	HP	-	PTC591500*	PTC591300*	PTC592000*	PTC591800	PTC591600	-
	LP	-	-	PTC591400	PTC592100	PTC591900	PTC591700	-
7 / 13"	HP	-	-	-	PTC591200*	PTC591000	PTC590700	-
	LP	-	-	-	-	PTC591100	PTC590800	-
6 / 11"	HP	-	-	-	-	-	PTC590400	PTC590200
	LP	-	-	-	-	PTC590600	PTC590500	PTC590300

*SWEP consumer co-contribution may be required dependent on clients available pressure care subsidy balance

* Sizes Available for Hire

L Low Risk **M** Medium Risk **H** High Risk **V** Very High Risk



M Suitable for **low to medium** risk patients

Ki Mobility Axiom General Cushions

- A General Use cushion offering all of the Axiom Difference design features. With its Pre-contoured shape, surface tension reducing well and high quality foam and cover materials, it is sure to be the professionals choice for years to come.
- Low to Moderate Risk
- Maximum User Weight 158 kg



HEIGHT (Size")	WIDTH x DEPTH (Size")						
	14 x 14	14 x 15	14 x 16	15 x 15	15 x 16	15 x 17	15 x 18
2 1/2"	PTC621900	PTC621905	PTC621910	PTC621915	PTC621920	PTC621925	PTC621930
	16 x 15	16 x 16	16 x 17	16 x 18	16 x 20	17 x 16	17 x 17
	PTC621935	PTC621940	PTC621945	PTC621950	PTC621955	PTC621960	PTC621965
	17 x 18	18 x 16	18 x 17	18 x 18	18 x 19	18 x 20	19 x 16
	PTC621970	PTC621975	PTC621980	PTC621985	PTC621990	PTC621995	PTC622000
	19 x 17	19 x 18	19 x 19	19 x 20	20 x 16	20 x 17	20 x 18
	PTC622005	PTC622010	PTC622015	PTC622020	PTC622025	PTC622030	PTC622035
	20 x 19	22 x 20	22 x 18				
	PTC622040	PTC622045	PTC622045				

*SWEP consumer co-contribution may be required dependent on clients available pressure care subsidy balance



M Suitable for **medium** risk patients

Ki Mobility Axiom S Cushions

- A Skin Protection cushion offering the Axiom Difference design elements with an emphasis on immersion and envelopment, Axiom S is a great entry level skin protection cushion.
- Material lead to a long-lasting, comfortable and functional product.
- Moderate Risk
- Maximum User Weight 158kg



HEIGHT (Size")	WIDTH x DEPTH (Size")						
	14 x 14	14 x 15	14 x 16	15 x 15	15 x 16	15 x 17	15 x 18
2 1/2"	PTC622100	PTC622105	PTC622110	PTC622115	PTC622120	PTC622125	PTC622130
	16 x 15	16 x 16	16 x 17	16 x 18	16 x 20	17 x 16	17 x 17
	PTC622135	PTC622140	PTC622145	PTC622150	PTC622155	PTC622160	PTC622165
	17 x 18	18 x 16	18 x 17	18 x 18	18 x 19	18 x 20	19 x 16
	PTC622170	PTC622175	PTC622180	PTC622185	PTC622190	PTC622195	PTC622200
	19 x 17	19 x 18	19 x 19	19 x 20	20 x 16	20 x 17	20 x 18
	PTC622205	PTC622210	PTC622215	PTC622220	PTC622225	PTC622230	PTC622235
	20 x 19	20 x 20	22 x 18	22 x 20			
	PTC622240	PTC622245	PTC622250	PTC622255			

*SWEP consumer co-contribution may be required dependent on clients available pressure care subsidy balance





Suitable for **medium - high** risk patients

Ki Mobility Axiom SPV Cushions

- Axiom SPV Viscoelastic material is both viscous (changes shape slowly) and elastic (it returns to its original shape). It deforms and returns to shape very slowly. There is a significant lag between when you deform viscoelastic foam and when it returns to shape. Because energy is effectively absorbed and dissipated during the time lag there is less reaction force pushing back after deformation.
- Moderate to High Risk
- Maximum User Weight 158kg
- Cushion height 3 Inches



HEIGHT (Size")	WIDTH x DEPTH (Size")						
	22 x 16	22 x 17	22 x 18	22 x 19	22 x 20	14 x 14	14 x 15
3"	PTC622300	PTC622305	PTC622310	PTC622315	PTC622320	PTC622325	PTC622330
	14 x 16	14 x 17	14 x 18	15 x 14	15 x 15	15 x 16	15 x 17
	PTC622335	PTC622340	PTC622345	PTC622350	PTC622355	PTC622360	PTC622365
	15 x 18	15 x 19	15 x 20	16 x 14	16 x 15	16 x 16	16 x 17
	PTC622370	PTC622375	PTC622380	PTC622385	PTC622390	PTC622395	PTC622400
	16 x 18	16 x 19	16 x 20	17 x 15	17 x 16	17 x 17	17 x 18
	PTC622405	PTC622410	PTC622415	PTC622420	PTC622425	PTC622430	PTC622435
	17 x 19	17 x 20	18 x 15	18 x 16	18 x 17	18 x 18	18 x 19
	PTC622440	PTC622445	PTC622450	PTC622455	PTC622460	PTC622465	PTC622470
	18 x 20	19 x 16	19 x 17	19 x 18	19 x 19	19 x 20	20 x 16
	PTC622475	PTC6224870	PTC622485	PTC622490	PTC622495	PTC622500	PTC622505
	20 x 17	20 x 18	20 x 19	20 x 20	21 x 18	21 x 19	21 x 20
	PTC622510	PTC622515	PTC622520	PTC622525	PTC622530	PTC622535	PTC622540

*SWEP consumer co-contribution may be required dependent on clients available pressure care subsidy balance



Suitable for **medium - high** risk patients

Ki Mobility Axiom SP Fluid Cushions

- The Axiom SP Fluid uses a Hydrolite fluid bladder instead of Viscoelastic Foam. The bladder rests directly under the super stretch outer cover, allowing it to conform to the tissues supporting the Ischial Tuberosities. Hydrolite is a non-Newtonian fluid that behaves as a solid under the force of gravity, but flows as a viscous fluid under load, which can help minimise shear. It is also incredibly light, eliminating the "weight penalty" of other fluid cushions.
- Moderate to High Risk
- Maximum User Weight 158kg
- Cushion height 3 Inches



HEIGHT (Size")	WIDTH x DEPTH (Size")						
	14 x 14	14 x 15	14 x 16	14 x 17	14 x 18	15 x 14	15 x 15
3"	PTC622600	PTC622605	PTC622610	PTC622615	PTC622620	PTC622625	PTC622630
	15 x 16	15 x 17	15 x 18	15 x 19	15 x 20	16 x 14	16 x 15
	PTC622635	PTC622640	PTC622645	PTC622650	PTC622655	PTC622660	PTC622665
	16 x 16	16 x 17	16 x 18	16 x 19	16 x 20	17 x 15	17 x 16
	PTC622670	PTC622675	PTC622680	PTC622685	PTC622690	PTC622695	PTC622700
	17 x 17	17 x 18	17 x 19	17 x 20	18 x 15	18 x 16	18 x 17
	PTC622705	PTC622710	PTC622715	PTC622720	PTC622725	PTC622730	PTC622735
	18 x 18	18 x 19	18 x 20	19 x 16	19 x 17	19 x 18	19 x 19
	PTC622740	PTC622745	PTC622750	PTC622755	PTC622760	PTC622765	PTC622770
	19 x 20	20 x 16	20 x 17	20 x 18	20 x 19	20 x 20	21 x 18
	PTC622775	PTC622780	PTC622785	PTC622790	PTC622795	PTC622800	PTC622805
	21 x 19	21 x 10	22 x 16	22 x 17	22 x 18	22 x 19	22 x 20
	PTC622810	PTC622815	PTC622820	PTC622825	PTC622830	PTC622835	PTC622840

*SWEP consumer co-contribution may be required dependent on clients available pressure care subsidy balance



Suitable for **medium - high** risk patients

Ride Forward Cushions

- The Forward Cushion surrounds the pelvis with supportive contours while reducing pressure around at-risk bony prominences. This helps improve postural control without compromise of skin protection for users with mild to moderate postural challenges and some sensation. The cushion helps to keep the hips level and positioned at the back of the chair for enhanced stability. The Forward Cushion is most effective when coupled with a Ride@ back support to aid in postural support.
- Moderate to High Risk
- Maximum User Weight 113kg
- Cushion height 3 Inches



HEIGHT (Size")	WIDTH x DEPTH (Size")						
	14 x 14	14 x 16	16 x 16	16 x 18	16 x 20	18 x 16	18 x 18
3"	PTC551571	PTC551569	PTC551572	PTC551576	PTC551568	PTC551573	PTC551574
	18 x 20	20 x 16	20 x 18	20 x 20			
	PTC551567	PTC551566	PTC551565	PTC551564			

*SWEP consumer co-contribution may be required dependent on clients available pressure care subsidy balance



Lifters



Aspire A150F Aluminium Folding Lifter



- Folds for Transport and Storage: Folds quickly and conveniently for storage or transport in the boot of the car
- Ergonomic Handset: The latest slimline technology from Linak fits neatly in the hand with an intuitive control panel. Battery and service indicator lights assist with service scheduling
- Off Set Leg Design: Provides additional accessibility around chairs and furniture in the home
- Leg Function: Simple foot operation to open or close legs for lifting stability or accessibility
- Quick Release Yoke Attachment: One touch release and attach mechanism, designed for the busy caregiver. Padded yoke for added patient safety
- Build Quality: Strong powder coated aluminium frame with industry leading Linak electronics and warranty provision
- Safety: Critical features include emergency stop button, emergency lowering and anti-entrapment technology, with both patient and caregiver safety at heart
- Intelligent Diagnostics: State of the art Linak Jumbo Care control system. Tracks usage and service requirements for safety and compliance
- Quality Locking Castors: 2 x 100mm rear locking castors for safety and manoeuvrability
- Tested and compliant to AS/NZS ISO 10535:2011 (the Australian standard for hoists)



Code	Description	Overall Height	Overall Length	Overall Width	Lifter Weight	S.W.L
LSS390600	Lifter A150F - Folding Lifter - Aluminium	1873 mm	1280 mm	660 mm	32.9 kg	150 kg

Oxford Journey Folding Standing Lifter



- Mobile compact patient lifter for transfer to a seated, lying or standing position
- Compact and lightweight allowing carers to manoeuvre in tight spaces
- Folds away for easy storage or transportation
- Unique adjustable 'cow-horn' shape supports a wide range of patient heights and sizes
- Adjustable knee pad
- Epoxy coated frame
- Electric hand control operation
- Emergency operation
- Easily manoeuvrable with 125 mm rear locking castors and 75 mm front twin swivel castors
- Electric leg gating



Code	Model	Length	Width	Height	Leg Gait	Lift Range	Product Weight	S.W.L
LSS377305	Journey Standing Lifter	1000 mm	685 mm	1130 - 1600 mm	590 - 875 mm	720 - 1530 mm	40.2 kg	155 kg

Slings

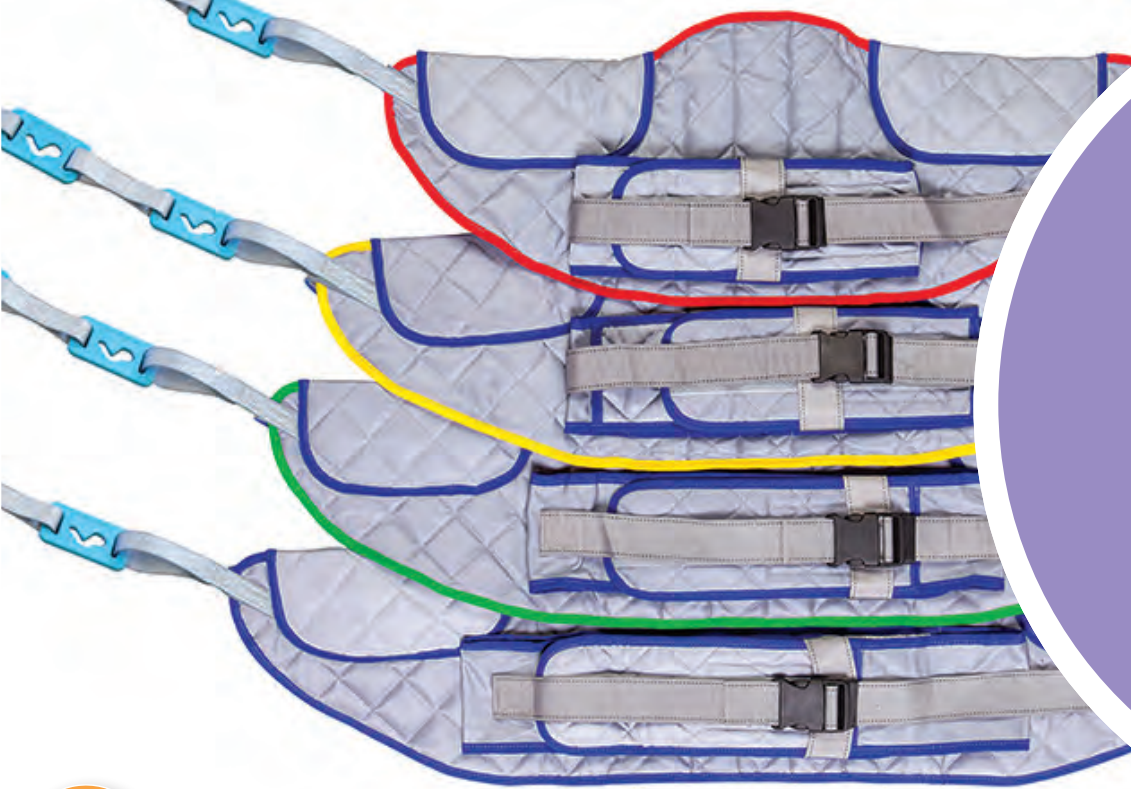

\$0
CONSUMER
CO-CONTRIBUTION



Aspire Deluxe General Purpose Sling

- Versatile sling offering body contoured fabric shaped for maximum patient comfort and support
- For FIM score 1 or 2

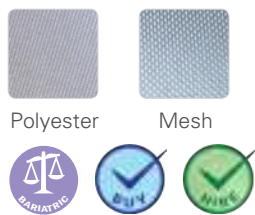

Code	Description	Size	Edge	S.W.L	Wty
LSS390700	Polyester - Loop	Small	Red	200 kg	1 Year
LSS390705	Polyester - Loop	Medium	Yellow	200 kg	1 Year
LSS390710	Polyester - Loop	Large	Green	300 kg	1 Year
LSS390715	Polyester - Loop	X-Large	Blue	300 kg	1 Year
LSS390716	Mesh - Loop	Small	Red	200 kg	1 Year
LSS390717	Mesh - Loop	Medium	Yellow	200 kg	1 Year
LSS390718	Mesh - Loop	Large	Green	300 kg	1 Year
LSS390719	Mesh - Loop	X-Large	Blue	300 kg	1 Year

\$0
CONSUMER
CO-CONTRIBUTION



Aspire Deluxe General Purpose Sling with Head Support

- This sling has a comfortable padded head support with rigidisers for posture management
- Body contoured fabric
- For FIM score 1 or 2



Code	Description	Size	Edge	S.W.L	Wty
LSS390740	Polyester - Loop	Small	Red	200 kg	1 Year
LSS390745	Polyester - Loop	Medium	Yellow	200 kg	1 Year
LSS390750	Polyester - Loop	Large	Green	300 kg	1 Year
LSS390755	Polyester - Loop	X-Large	Blue	300 kg	1 Year
LSS390756	Mesh - Loop	Small	Red	200 kg	1 Year
LSS390757	Mesh - Loop	Medium	Yellow	200 kg	1 Year
LSS390758	Mesh - Loop	Large	Green	300 kg	1 Year
LSS390759	Mesh - Loop	X-Large	Blue	300 kg	1 Year

\$0
CONSUMER
CO-CONTRIBUTION



Aspire Deluxe Standing Sling

- Intuitively designed, this sling offers generous underarm padding and a reinforced wide-cut back for comfort.
- Quilted and padded under arm to enhance patient comfort
- Padded back support with stays for stability and rigidity
- Security strap features velcro and buckle fastening for easy positioning and added safety.
- For FIM score 3 or 4



Code	Description	Size	Edge	S.W.L	Wty
LSS390720	Polyester - Loop	Small	Red	200 kg	1 Year
LSS390725	Polyester - Loop	Medium	Yellow	200 kg	1 Year
LSS390730	Polyester - Loop	Large	Green	300 kg	1 Year
LSS390735	Polyester - Loop	X-Large	Blue	300 kg	1 Year

Mobility Scooters



\$0*
CONSUMER
CO-CONTRIBUTION



Pathrider 130 XL Pursuit Scooter

Pride

- Large 33 cm (13") pneumatic tyres for excellent outdoor performance
- Full lighting package including directional signals and angle adjustable
- LED headlight
- Easy drive tiller with wraparound handles
- Front basket standard
- Easily accessible tie down points (for transport of unoccupied scooter)
- Rearview mirror standard
- Front and rear suspension handle rugged outdoor terrain
- Rear storage bag



*SWEP consumer co-contribution may be required dependent on accessories/modifications requested

Code	Description	Length	Width	Max. Speed	Range	Product Weight	S.W.L	Warranty
SCT670571	Pathrider 130XL Pursuit - Red	1359 mm	635 mm	12.4 km/h	Up to 25 km	73 kg (w/out batteries)	159 kg	2 Years (1 Year batteries)

\$0*
CONSUMER
CO-CONTRIBUTION



Victory 10 LX Scooter

Pride

- A sporty, sleek outdoor scooter
- Full digital displaying speedometer/odometer
- Full suspension system
- High back, adjustable seat
- Powerful front/rear lighting kit
- Large rear storage pod included as standard



*SWEP consumer co-contribution may be required dependent on accessories/modifications requested

Code	Description	Length	Width	Max. Speed	Range	Product Weight	S.W.L	Warranty
SCT670640	Victory 10 LX Scooter - 4 Wheel Red	1194 mm	565 mm	9 km/h	Up to 26 km	120 kg (w/out batteries)	181 kg	2 Years (1 Year batteries)



Seat Walkers / Rollators

\$0
CONSUMER
CO-CONTRIBUTION



Aspire Classic 8" Seat Walker

- Ultra-soft hand brakes with palm-ball lock effortlessly, offering increased comfort for users with arthritis or wrist/hand joint pain
- 8 inch diameter solid, puncture-proof wheels provide increased maneuverability over various surfaces
- Rustproof, robust aluminium frame provides durability and stability and whilst remaining very light to manoeuvre and transport
- Curved and padded backrest offers comfortable seated support and flips up/removes easily for folding/storage
- Handle height adjusts quickly with hand wheels for optimal sizing
- Easy folding mechanism facilitates storage and transportation
- Padded seat flips up easily for access to storage bag (supplied) or for folding
- Swiveling front castor wheels increase maneuverability
- Anatomically designed, latex-free handles allow comfortable grip especially for users with arthritis



Code	Description	Overall Height	Overall Length	Overall Width	Seat Depth	Seat Width	Seat Height	Backrest Height	Folded Width	Castor Size	S.W.L
WAF705700RE	Classic 8" Seat Walker - Red	817 - 972 mm	660 mm	628 mm	305 mm	355 mm	584 mm	815 mm	200 mm	8"	130 kg
WAF705700BL	Classic 8" Seat Walker - Blue	817 - 972 mm	660 mm	628 mm	305 mm	355 mm	584 mm	815 mm	200 mm	8"	130 kg

\$0
CONSUMER
CO-CONTRIBUTION



Aspire Classic 6" Seat Walker

- Ultra-soft hand brakes with palm-ball lock effortlessly, offering increased comfort for users with arthritis or wrist/hand joint pain
- Handle height adjusts quickly with hand wheels for optimal sizing
- Rustproof, robust aluminium frame provides durability and stability and whilst remaining very light to manoeuvre and transport
- Easy folding mechanism facilitates storage and transportation
- Anatomically designed, latex-free handles allow comfortable grip especially for users with arthritis
- Curved and padded backrest offers comfortable seated support and flips up/removes easily for folding/storage
- Padded seat flips up easily for access to storage bag (supplied) or for folding
- Swiveling front castor wheels increase maneuverability
- 6 inch diameter solid, puncture-proof wheels provide increased maneuverability over various surfaces



Code	Description	Overall Height	Overall Length	Overall Width	Seat Depth	Seat Width	Seat Height	Backrest Height	Folded Width	Castor Size	S.W.L
WAF709600RE	Classic 6" Seat Walker - Red	760 - 915 mm	624 mm	615 mm	305 mm	355 mm	528 mm	769 mm	200 mm	6"	130 kg
WAF709600BL	Classic 6" Seat Walker - Blue	760 - 915 mm	624 mm	615 mm	305 mm	355 mm	528 mm	769 mm	200 mm	6"	130 kg



\$0
CONSUMER
CO-CONTRIBUTION



Aspire XL Seat Walker



- Ultra-soft hand brakes with palm-ball lock effortlessly, offering increased comfort for users with arthritis or wrist/hand joint pain
- Handle height adjusts quickly with hand wheels for optimal sizing
- Rustproof, robust aluminium frame provides durability and stability and whilst remaining very light to manoeuvre and transport
- Easy folding mechanism facilitates storage and transportation
- Anatomically designed, latex-free handles allow comfortable grip especially for users with arthritis
- Padded seat flips up easily for access to storage bag (supplied) or for folding
- Curved and padded backrest offers comfortable seated support and flips up/removes easily for folding/storage
- Swiveling front castor wheels increase maneuverability 8" diameter solid, puncture-proof wheels provide increased maneuverability over various surfaces
- Easy wipe-clean surfaces
- Wide padded seat and increased 180kg safe working load for large users



Code	Description	Overall Height	Overall Length	Overall Width	Seat Depth	Seat Width	Seat Height	Backrest Height	Folded Width	Castor Size	S.W.L
WAF750020SL	XL Seat Walker	850 - 982 mm	697 mm	732 mm	340 mm	495 mm	560 mm	850 mm	230 mm	8"	180 kg

\$0
CONSUMER
CO-CONTRIBUTION



Bariatric Rollator

- Easy to operate walking aid developed for the larger person to increase their sense of security and safety
- Suitable for bariatric use with a higher weight capacity 227kg (35st)
- Anatomically designed handles allow comfortable grip
- Arthritic friendly looped cable brakes activate effortlessly
- Suitable for both indoor and outdoor use
- Padded seat flips up easily for access to storage basket or for folding
- Padded backrest offers comfortable support
- Foldable for easy storage and transportation
- Handle height can be adjusted between 88cm – 100cm (34.5" - 39") to suit the user
- Fitted with solid 20cm (8") puncture proof tyres for easy manoeuvrability and durability
- Includes a basket for storing essential items
- Available in a Metallic Blue finish



Code	Description	Overall Height	Seat Height	Overall Width	Overall Depth	Seat Depth	Seat Width	Unit Weight	S.W.L
WAF705100	Bariatric Rollator	880 - 1000 mm	550 mm	690 mm	690 mm	330 mm	460 mm	12 kg	227 kg





Walking Frames & Aids

\$0
CONSUMER
CO-CONTRIBUTION



Aluminium Folding Walking Frame

- Provides assistance for those who have difficulty walking
- Folds flat for easy transportation and storage
- Lightweight aluminium frame ideal for indoor use
- Height adjustable to suit user requirements
- Supplied with four rubber tips



Code	Description	Width	Handle Height	Ferrule	Product Weight	S.W.L	Warranty
WAF706700	A/ Folding Walking Frame - Small	610 mm	710 - 787 mm	25 mm	2 kg	127 kg	1 Year
WAF706800	A/ Folding Walking Frame - Medium	610 mm	787 - 860 mm	25 mm	2 kg	127 kg	1 Year
WAF706900	A/ Folding Walking Frame - Large	610 mm	860 - 935 mm	25 mm	2 kg	127 kg	1 Year



Nimbo Lightweight Pediatric Walking Aid

- Lightweight aluminium frame
- Tool free height adjustment
- Latex free handles with flanged ends
- Soft rubber wheels adhere to any surface and prevent Nimbo from sliding backwards
- One directional rear wheels with aluminium ratchet and pin mechanism
- Folds easily for convenient storage and transportation
- Available in 5 sizes - Specify size on request



Code	Description	Total Width	Unit Weight	S.W.L
PED480800	Nimbo Walking Aid	610 - 740 mm	4 - 7 kg	34 - 113 kg

Folding Wheelchairs



Aspire Evoke 2 + Evoke 2 HD Wheelchair



Seat & Backrest Height Adjustable



Customisable Backrest

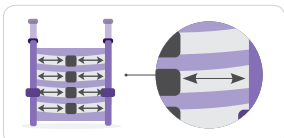

Seat Depth Adjustable



Quick release 24" solid rear wheels



Height adjustable back canes 17" - 19"

Optional Contoured Padded Overlay



Swing-back armrests. (Height and depth adjustable option available)

Swing away and removable legrests

Height and angle adjustable footrests

Height and angle adjustable front castors 8"

Folding Lightweight Aluminium Design



*SWEP consumer co-contribution may be required dependent on accessories/modifications requested

Code	Description	Seat Width	Overall Width	Seat Depth	Seat Height	Backrest Height	Armrest Height	S.W.L
MWS449500*	Evoke 2 - 350 mm (14") *Not available for HIRE	350 mm (14")	560 mm	400 - 475 mm	440 - 480 mm	430 - 490 mm	205 - 225 mm	140 kg
MWS449510*	Evoke 2 - 400 mm (16") *Not available for HIRE	400 mm (16")	610 mm	400 - 475 mm	440 - 480 mm	430 - 490 mm	205 - 225 mm	140 kg
MWS449520	Evoke 2 - 450 mm (18")	450 mm (18")	660 mm	400 - 475 mm	440 - 480 mm	430 - 490 mm	205 - 225 mm	140 kg
MWS449530*	Evoke 2 - 500 mm (20") *Not available for HIRE	500 mm (20")	710 mm	400 - 475 mm	440 - 480 mm	430 - 490 mm	205 - 225 mm	140 kg
MWS449540	Evoke 2 (HD) - 570 mm (22")	570 mm (22")	780 mm	400 - 475 mm	440 - 480 mm	430 - 490 mm	205 - 225 mm	180 kg
MWS449550*	Evoke 2 (HD) - 610 mm (24") *Not available for HIRE	610 mm (24")	820 mm	400 - 475 mm	440 - 480 mm	430 - 490 mm	205 - 225 mm	180 kg



TiLite Aero X Manual Wheelchair

- Clean modern lines and configurability
- Folding Frame
- Full adjustability
- Multiple configurations that include heavy-duty, hemi, and amputee options.
- Add superior rolling dynamics and full adjustability
- This product is scripted



Code	Description	Seat Width	Seat Depth	Seat Height	Backrest Height	S.W.L
MWC427479	TiLite Aero X Manual Wheelchair	400mm (16") 450mm (18") 500mm (20")	400mm (16"), 450mm (18"), 500mm (20")	340 - 545mm	400 - 500mm	120kg



Ki Mobility Rogue Wheelchair

- Ultra lightweight at 4.8kg (transport weight)
- Ergonomic locking backrest can be actuated with one hand for easy transfers
- 6° recline backrest
- RP tuning allows the chair to be adjusted while occupied
- Tower & side frame adjustment system



Code	Description	Seat Width	Seat Depth	Seat Height	Backrest Height	S.W.L
MWC427492	Ki Mobility Rogue Wheelchair	300 - 351mm (12-20")	360 - 510mm (14-20")	340 - 520mm (13.5-20.5")	280 - 508mm (11-20")	124kg



Tilt & Recline Wheelchairs



Aspire Rehab RS Wheelchair *Low - Medium Level Rehabilitation*



Attendant Operated Drum Brakes & Push-to-lock Handbrakes

Removable, Height & Depth Adjustable Armrest

Tilt & Recline Functionality



Quick Release, Height & Depth Adjustable Solid 24" Rear Wheels

Height Adjustable 6" Castors

Height & Angle Adjustable Footrest



Height, Depth, Angle & Width Adjustable Removable Headrest



Depth Adjustable Seat, Height & Depth Adjustable Backrest



Swing-away, Removable, Padded & Elevating Legrest



Code	Description	Seat Width	Overall Width	Seat Depth	Seat Height	Backrest Height	Armrest Height	S.W.L
MWS449600*	Rehab RS - 410 to 460mm (16 - 18") <i>*Not available for HIRE</i>	410 - 460 mm (16" - 18")	690 mm	440 - 530 mm	Front = 410 - 440 mm Rear = 400 - 475 mm	460 - 710 mm	310 - 460 mm	180 kg
MWS449610	Rehab RS - 460 to 510mm (18 - 20")	460 - 510 mm (18" - 20")	740 mm	440 - 530 mm	Front = 410 - 440 mm Rear = 400 - 475 mm	460 - 710 mm	310 - 460 mm	180 kg
MWS449620*	Rehab RS - 510 to 560mm (20 - 22") <i>*Not available for HIRE</i>	510 - 560 mm (20" - 22")	790 mm	470 - 560 mm	Front = 410 - 440 mm Rear = 400 - 475 mm	460 - 710 mm	310 - 460 mm	180 kg



Paediatric Wheelchairs

\$0*
CONSUMER CO-CONTRIBUTION



Aspire Rehab RX JNR Wheelchair



- The Aspire REHAB RX JNR is designed for advanced postural support and pressure care for children via easy repositioning and advanced adjustability.
- HIGH LEVEL COMPLEX REHAB SOLUTION - Tilt-In-Space (TIS) functionality promotes increased comfort and improved positioning. As well as this, it allows body weight redistribution to help alleviate pressure areas.
- HIGHLY ADJUSTABLE - The wide array of adjustable features fulfil many clinical requirements and are geared towards independence and comfort
- EASY TO CLEAN - Wipe clean surfaces ensure infection control compliance.
- CRASH TESTED - The Aspire REHAB RX JNR is tested to AS/NZS3696.196
- ADVANCED COMFORT - Breathable PU coated multi-stretch fabric on seat and back cushions ensure optimal skin microclimate, comfort and improve pressure care outcomes. Multi-layer, castellated seat and back cushions with internal postural reinforcement optimise comfort and positioning.



*SWEP consumer co-contribution may be required dependent on accessories/modifications requested

Code	Description	Seat Width	Overall Width	Seat Depth	Seat Height	Backrest Height	Armrest Height	S.W.L
MWS449630	Rehab RX JNR	320 - 370 mm (13" - 15")	600 mm	440 - 490 mm	Front = 410 - 440 mm Rear = 400 - 475 mm	460 - 710 mm	310 - 460 mm	180 kg

\$0*
CONSUMER CO-CONTRIBUTION



Action 3 Junior Wheelchair

- Invacare Action 3 Junior is a lightweight, foldable paediatric wheelchair designed for children aged between 3 and 15 years
- Action 3 Junior has been developed to match the individual needs of the child and can grow as they grow



*SWEP consumer co-contribution may be required dependent on accessories/modifications requested

Code	Description	Seat Width	Seat Depth	Seat to Floor Height	Unit Weight	S.W.L
MWS449190	Action 3 Junior	300 - 360 mm	200 - 360 mm	410 - 460 mm	7.2 kg	80 kg



Ki Mobility Little Wave Clik Wheelchair

- Index system for easy growth positioning and adjustment options
- Built in adjustment
- 5th wheel option for extra balance
- Swing away arms



Code	Description	Seat Width	Seat Depth	Seat Height	Backrest Height	S.W.L
MWC427493	Ki Mobility Little Wave Clik Wheelchair	200 - 460mm (8-18")	200 - 460mm (8-18")	290 - 510mm (11.5-20")	229 - 457mm (9-18")	75 kg



Ki Mobility Rogue XP Wheelchair

- Ultra lightweight at 4.8kg (transport weight)
- Spinergy backrest release cable
- RP tuning allows the chair to be adjusted while occupied
- Tower & side frame adjustment system



Code	Description	Seat Width	Seat Depth	Seat Height	Backrest Height	S.W.L
MWC427494	Ki Mobility Rogue XP Wheelchair	254 - 457mm (10-18")	254 - 508mm (10-20")	343 - 520mm (13.5-20.5")	280 - 508mm (11-20")	90 kg



Ki Mobility Focus CR Wheelchair

- Dual point complex rotation
- Secure & Smart tilt
- Easy adjustment without any disassembly
- Wide tyre options
- Flip-up spring-loaded anti-tips



Code	Description	Seat Width	Seat Depth	Seat Height	Backrest Height	S.W.L
MWC427550	Ki Mobility Focus CR Wheelchair	360 - 560mm (14-22")	360 - 560mm (14-22")	330 - 520mm (13 - 20.5")	457mm - 686mm (18-27")	136 kg



Wheelchair Accessories

NOTE : These items are not awarded on the SWEP contract.
These items are available for purchase on approval from SWEP.



Code	Description	Wheelchair Compatability		
		Evolve 2	Rehab RS	Rehab RX JNR
1 WCA848100	WChair Elevating Legrest - Left - 320 to 410mm	●	●	●
WCA848110	WChair Elevating Legrest - Right - 320 to 410mm	●	●	●
WCA848120	WChair Elevating Legrest - Left - 450 to 510mm	●	●	X
WCA848130	WChair Elevating Legrest - Right - 450 to 510mm	●	●	X
2 WCA848220	WChair Stump Support - Left - Silver - 320 to 450mm	●	●	●
WCA848230	WChair Stump Support - Right - Silver - 320 to 450mm	●	●	●
WCA848240	WChair Stump Support - Left - Silver - 500-610mm	●	●	X
WCA848250	WChair Stump Support - Right - Silver - 500-610mm	●	●	X
3 WCA848270	WChair Anti Tip Bar	●	●	●
4 WCA848280	WChair IV Pole	●	●	●
5 WCA848290	WChair Oxygen Bottle Holder	●	X	X
6 WCA848300	WChair Lap Belt - Metal Seatbelt Buckle	●	●	●
WCA848560	WChair Tray - 320mm to 410mm	X	●	●
7 WCA848570	WChair Tray - 460mm to 510mm	X	●	X



Aidacare have an extensive free-to-use video library containing safe use Product and Training videos. All of these are available at www.aidacare.com.au/knowledge/videos

For more information, please contact your local Aidacare representative or call **1300 133 120**.

Setting Up Your Active Air 8 Mattress



Choosing the Right Lift Chair

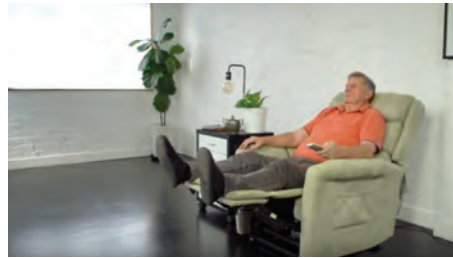

ROHO Cushion Setup



Aspire Walkers



Aspire Evoke 2 Manual Wheelchair



Aspire Rehab RX & RS Tilt In Space Wheelchairs



Aidacare Aspire Lifters & Slings



Aspire Slings



Choosing & Fitting the Right Sling



Aidacare Back Safety

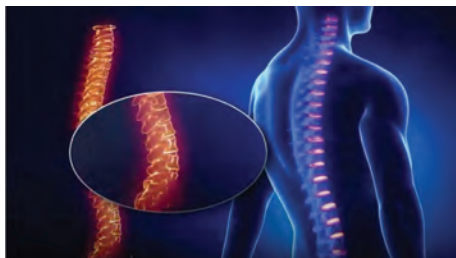

Safe Resident Handling - The 3C's

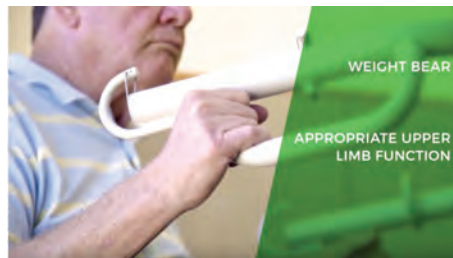

Manual Handling - Lie to Sit



Manual Handling - Floor Lift



Manual Handling - Sit to Sit



Manual Handling - Sit to Stand





1300 133 120

